

Step 6

There is a locking latch on the bottom wall mount only.

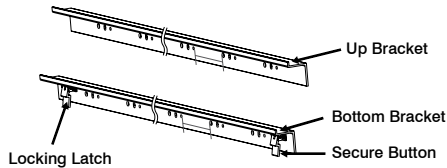

Fig 16

Step 7

Fix the mounts onto the wall separately. (Fig 17-18)
(For 100" - height (h) = 1356mm & 115" - height (h) = 1542mm).

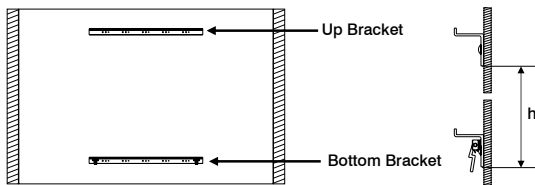

Fig 17

Fig 18

Step 8

Hook screen onto the top mount and bottom mount. (Fig 19-20)

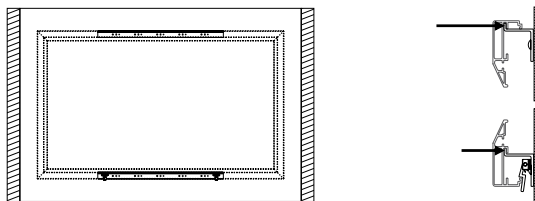

Fig 19

Fig 20

Step 9

To uninstall the screen, please press the latch towards the wall to release bottom frame from bottom mount, then lift the screen a little to release it totally from top and bottom groove of the mounts. (Fig 21-22)

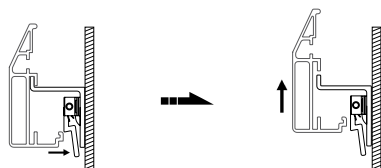

Fig 21

Fig 22

Happy Viewing!

gv

GRANDVIEW®

Protecting Your Screen:

- Keep away from direct sunlight or high temperatures.
- Examine both the front and back surfaces before retracting into the case to make sure it is free of dust, dirt, insects or other foreign matter.
- Use a soft brush or cloth to lightly remove any foreign particles.

Cleaning Your Screen:

- Do not use any solvents, chemicals or abrasive cleaners on the screen surface.
- Use a mild detergent with warm water to remove any marks on the surface or screen case.
- Always immediately dab the screen with a lint free soft cloth to avoid soap marks.
- Do not scrub the surface.

Warranty: 12 Months

For more information please go to
www.projectisle.com.au
or call 1300 88 11 79

gv

GRANDVIEW®



projectisle
.com.au

Where Projectors Roam Free

Grandview Flocked Frame
Screen User Manual

Required (not supplied)

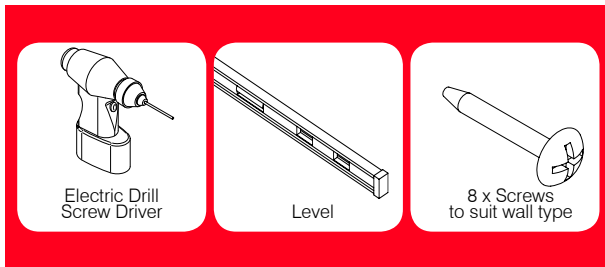

Supplied parts

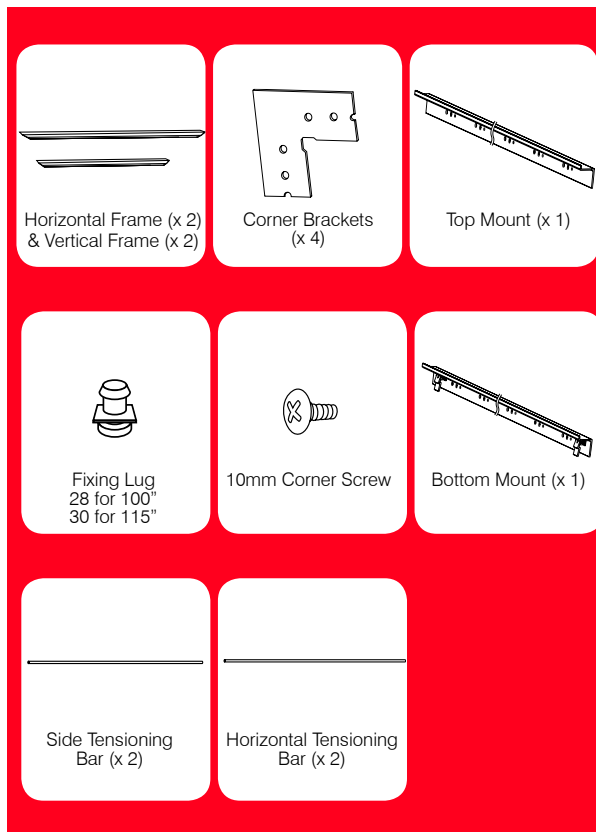

Step 1

Lay each section of the frames on a tidy flat surface. (Fig 1)

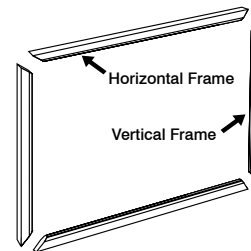

Fig 1

Step 2

Slide Fixing Lugs into grooves on the reverse side of frames. (Fig 2 - 3)

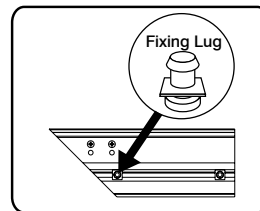

Fig 2

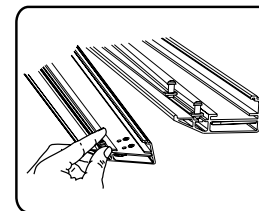

Fig 3

Step 3

Insert both horizontal and vertical frame sections with the corner stakes. Ensure all joints are square and then lock off by tightening with the screws provided. (Fig 4-7)

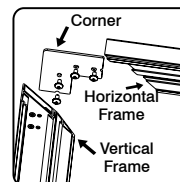

Fig 4

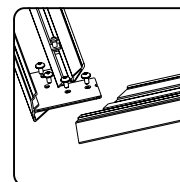

Fig 5

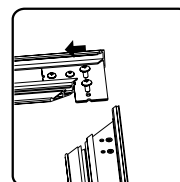

Fig 6

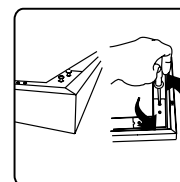

Fig 7

Step 4

Unfold screen fabric and insert the tensioning bars into the fabric grooves. (Fig 8-10)

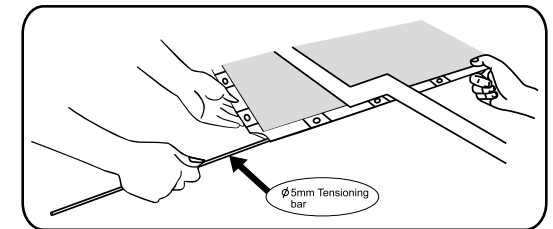

Fig 8

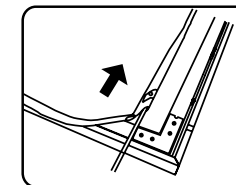

Fig 9

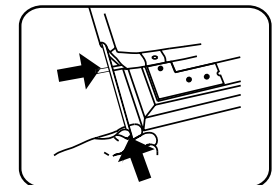

Fig 10

Step 5

Align fixing lugs and the eyelets provided on the fabric. Using the tensioning bar, pull fabric eyelets over the lugs. (Tip: Arrange horizontal tensioning bars first then side tensioning bars). (Fig 11-15)

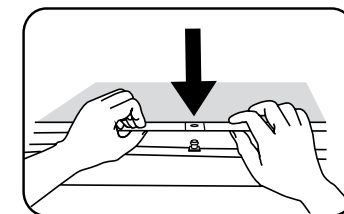

Fig 11

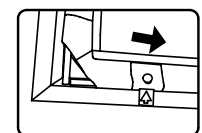

Fig 13

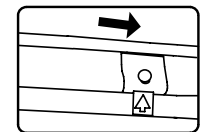

Fig 14

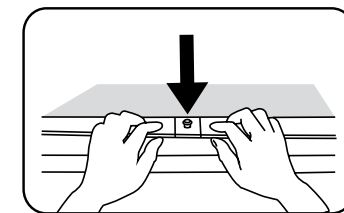

Fig 12

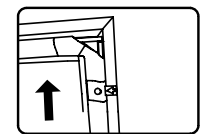

Fig 15